

Akuvox Smart Intercom



R29 Series Door Phone User Manual

About This Manual

Thank you for choosing Akuvox's R29 series door phone. This manual is intended for end users who need to properly configure the door phone. This manual is applicable to 29.31.1.7xx version, and it provides all functions' configurations of R29 series door phone. Please visit Akuvox forum or consult technical support for any new information or latest firmware.

Note: Please refer to universal abbreviation form in the end of manual when meet any abbreviation letter.

Content

1. Product Overview.....	1
1.1. Instruction.....	1
1.2. Connector Introduction.....	2
2. Daily use.....	3
2.1. Starting.....	3
2.2. Make a Call.....	4
2.2.1. Call From Digital Keypad.....	4
2.2.2. Call From Phonebook.....	5
2.2.3. Call From Speed Dial.....	6
2.2.3.1. Building theme.....	6
2.2.3.2. Villa theme or Office theme.....	6
2.3. Receive a Call.....	6
2.4. Unlock.....	7
2.4.1. Unlock by Pin Codes.....	7
2.4.2. Unlock by Face.....	8
2.4.3. Unlock by RFID cards.....	8

2.4.4. Unlock by DTMF codes..... 9

1. Product Overview

1.1. Instruction

R29 series is an Android-based IP video door phone with a touch screen. It incorporates audio and video communications, access control and video surveillance.

Its finely-tuned Android OS allows for feature customization to better suit the habit of usage of local people. R29S's multiple ports, such as RS485 and Wiegand ports, can be used to easily integrate external digital systems, such as elevator controller and fire alarm detector, helping to create a holistic control of building entrance and its surroundings and giving occupants a great sense of security.

It is applicable to multi-storey residential buildings, high-rise office buildings and their complexes.

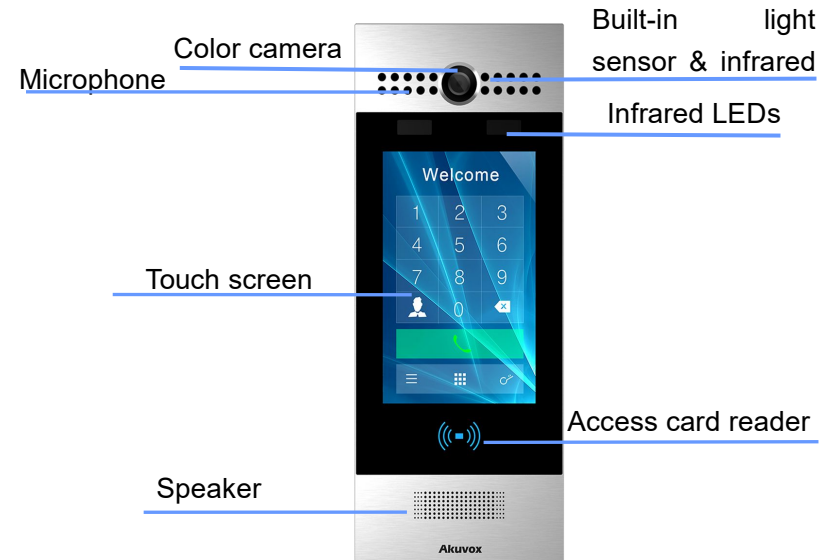

Figure 1.1 Product Description

1.2. Connector Introduction

Ethernet (POE): Ethernet (POE) connector which can provide both power and network connection.

12V/GND: External power supply terminal if POE is not available.

WG_D0/1: Wiegand terminal for wiegand access control.

RS485A/B: RS485 terminal for automation system control (e.g. Elevator control).

DOORA/B/C: Trigger signal input terminal (e.g. Press indoor button to open relay).

RelayA/B/C: NO/NC Relay control terminal.

Note: The general door phone interface diagram is only for reference.

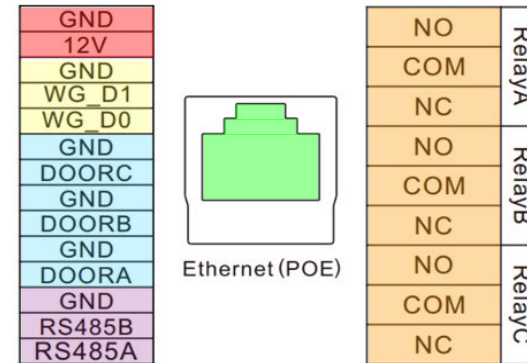

Figure 1.2-1 Connection introduction

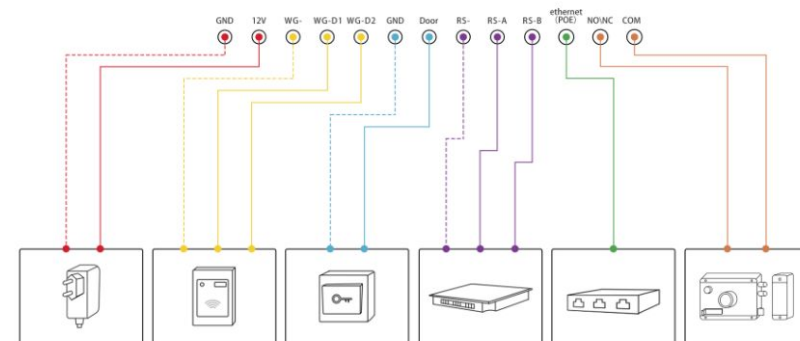

Figure 1.2-2 General interface

2. Daily use

2.1. Starting

When booting R29X first time, users need to choose a suitable display language for device. Tap **Start** to start the selection. R29X support 4 languages, including **French, English, Spanish and Chinese**. Then choosing the proper display theme according to specific application scenarios. R29 supports 3 themes, including **Villa, Building and Office**. Tap **Skip** if users are adopting Building theme and English language. Building theme and English language by default.

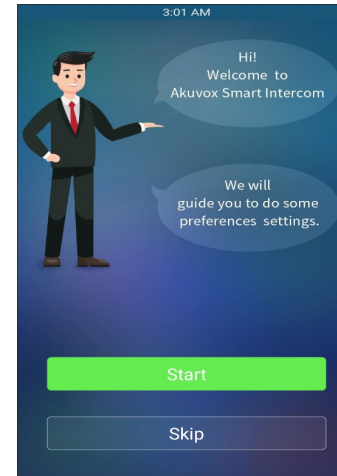

Figure 2.1.1-1 Starting

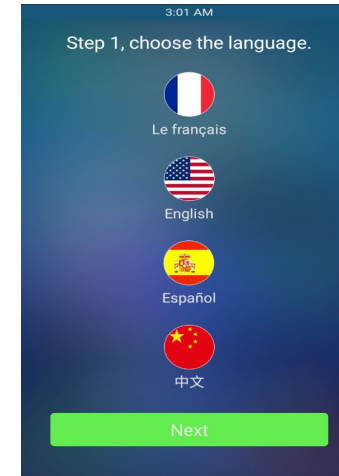

Figure 2.1.1-2 Language selection

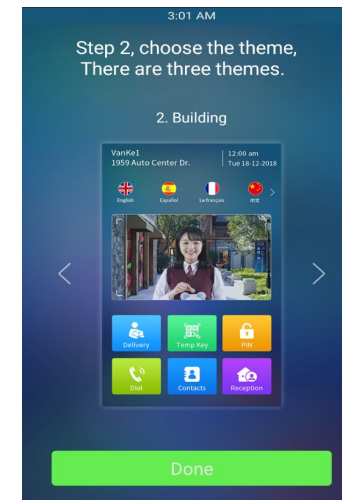

Figure 2.1.1-3 Theme selection

2.2. Make a Call

There are three ways to make a call from the door phone to monitor units, which can be an indoor monitor or an intercom app.

2.2.1. Call From Digital Keypad

Press **Dial** (Building theme) or **Call** (Villa theme or Office theme) to enter the dial interface. Enter the number to call on the digital keypad, and press the dial icon.

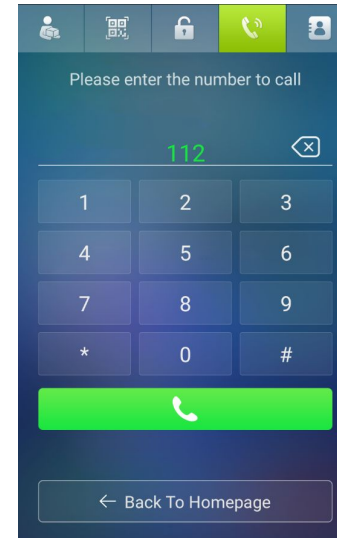

Figure 2.2.1-1 Dial interface
(Building theme)

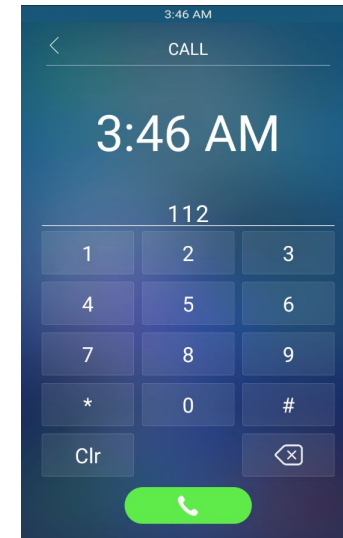

Figure 2.2.1-2 Dial interface
(Villa or Office theme)

2.2.2. Call From Phonebook

Tap **Contacts** to enter the phonebook. In the phonebook interface, to find a specific occupant, scroll up or down the pre-imported contact list, which is either a room number, an occupant's name, or the combination of both. It also supports searching the list by alphabet and then clicking the dial key next to the found contact.

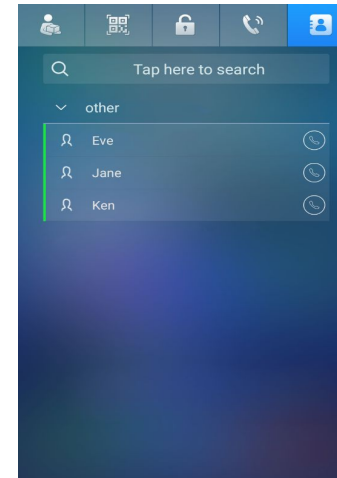

Figure 2.2.2-1 Phonebook interface

(Building theme)

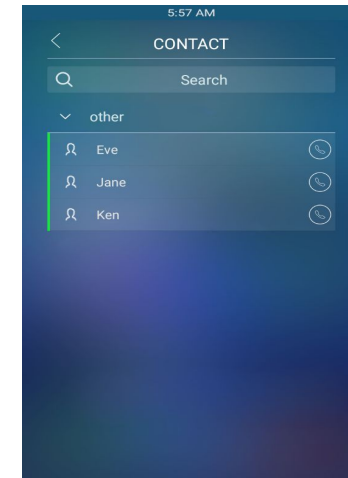

Figure 2.2.2-2 Phonebook interface

(Villa theme)

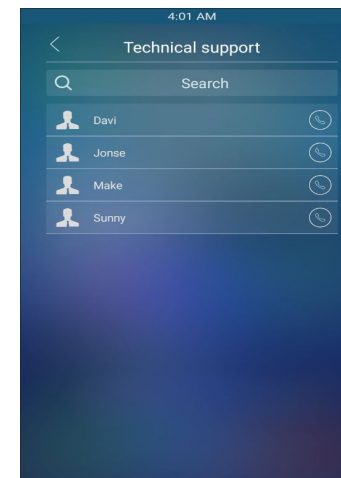

Figure 2.2.2-3 Phonebook interface

(Office theme)

2.2.3. Call From Speed Dial

2.2.3.1. Building theme

Press **Reception** to make the call directly.

2.2.3.2. Villa theme or Office theme

Press **Call** to enter the call interface, choose a speed dial number that users want to call directly.

2.3. Receive a Call

When a monitor unit calls the door phone, it will auto answer the incoming call by default. There is no need to press any answer key.

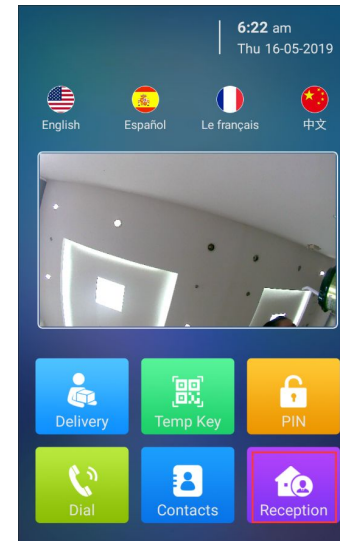

Figure 2.2.3.1 Reception

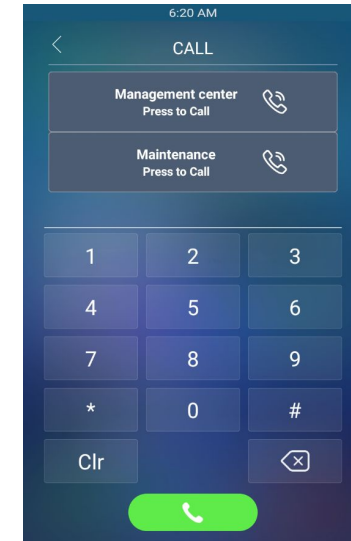

Figure 2.2.3.3 Speed dial

2.4. Unlock

2.4.1. Unlock by Pin Codes

Unlock the door by using predefined public pin or private pin. Press **PIN** icon to enter the PIN code interface, enter the “pin code” and press **Confirm** icon to unlock, then you will hear “Welcome, please coming” and the screen will show “Opening door succeeded”. If users input the wrong pin code, the screen will shows “Invalid password”.

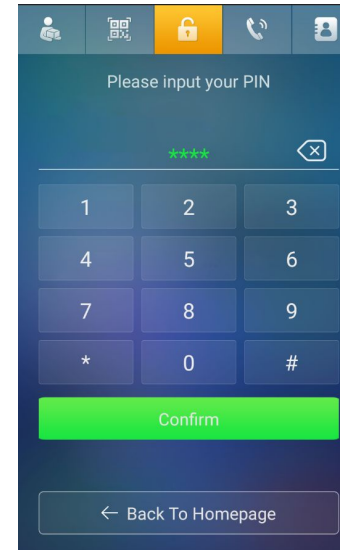

Figure 2.4.1-1 Unlock by pin code
(Building theme)

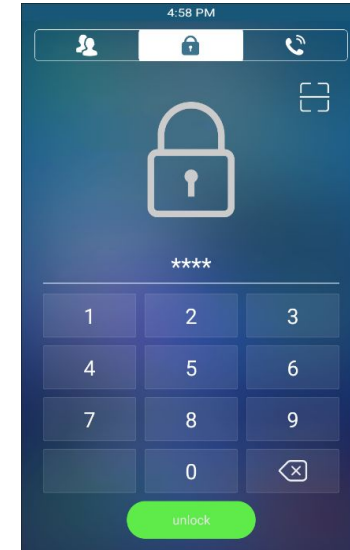

Figure 2.4.1-2 Unlock by pin code
(Villa or Office theme)

2.4.2. Unlock by Face

Stand in front of the camera of R29X in 0.5-1m and look at the camera, the device will recognize the predefined face less than 0.6s in the main interface(Building theme) or enter the “Password”(Villa or office theme) interface and it will announce “Welcome, please come in” and show “Opening door succeeded”. Otherwise it will shows “ Authentication failed ! ” .

The device must be in idle. And please make sure there is only one face in the recognition window at a time. And if the UI is villa or office theme, please click the Password page manually or set the Password page as default.

2.4.3. Unlock by RFID cards

Place the predefined users card in RFID cards reader to unlock. Under normal conditions, the phone will announce “ Welcome, please coming ” and the screen will show “Opening door

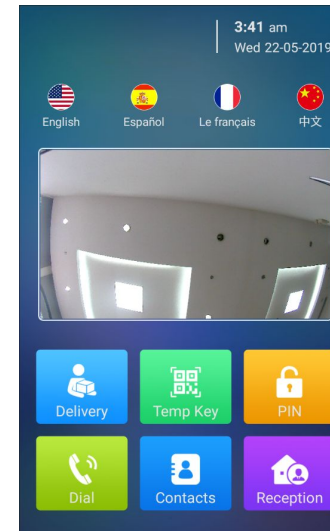

Figure 2.4.2-1 Unlock by face
(Building theme)

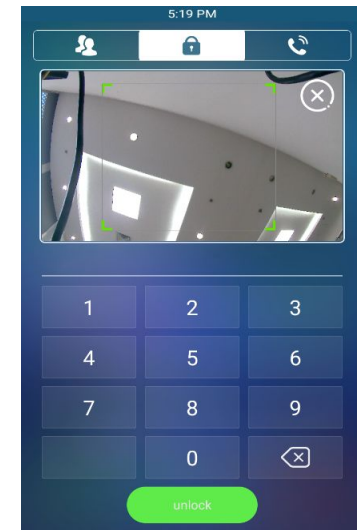

Figure 2.4.2-2 Unlock by face
(Villa or Office theme)

succeeded”. If the card has not been registered, the phone will show “Invalid password”.

2.4.4. Unlock by DTMF codes

During the calling, the president can press the predefined DTMF codes to remote unlock the door.

:

Abbreviations

ACS: Auto Configuration Server

Auto: Automatically

AEC: Configurable Acoustic and Line Echo Cancelers

ACD: Automatic Call Distribution

Autop: Automatic Provisioning

AES: Advanced Encryption Standard

BLF: Busy Lamp Field

COM: Common

CPE: Customer Premise Equipment

CWMP: CPE WAN Management Protocol

DTMF: Dual Tone Multi-Frequency

DHCP: Dynamic Host Configuration Protocol

DNS: Domain Name System

DND: Do Not Disturb

DNS-SRV: Service record in the Domain Name System

FTP: File Transfer Protocol

GND: Ground

HTTP: Hypertext Transfer Protocol

HTTPS: Hypertext Transfer Protocol Secure

IP: Internet Protocol

ID: Identification

IR: Infrared

LCD: Liquid Crystal Display

LED: Light Emitting Diode

MAX: Maximum

POE: Power Over Ethernet

PCMA: Pulse Code Modulation A-Law

PCMU: Pulse Code Modulation μ -Law

PCAP: Packet Capture
PNP: Plug and Play
RFID: Radio Frequency Identification
RTP: Real-time Transport Protocol
RTSP: Real Time Streaming Protocol
MPEG: Moving Picture Experts Group
MWI: Message Waiting Indicator
NO: Normal Opened
NC: Normal Connected
NTP: Network Time Protocol
NAT: Network Address Translation
NVR: Network Video Recorder
ONVIF: Open Network Video Interface Forum

SIP: Session Initiation Protocol
SNMP: Simple Network Management Protocol
STUN: Session Traversal Utilities for NAT
SMTP: Simple Mail Transfer Protocol
SDMC: SIP Devices Management Center
TR069: Technical Report069
TCP: Transmission Control Protocol
TLS: Transport Layer Security
TFTP: Trivial File Transfer Protocol
UDP: User Datagram Protocol
URL: Uniform Resource Locator
VLAN: Virtual Local Area Network
WG: Wiegand

Contact us

For more information about the product, please visit us at www.akuvox.com or feel free to contact us by

Sales email: sales@akuvox.com

Technical support email: techsupport@akuvox.com

Telephone: +86-592-2133061 ext.7694/8162



We highly appreciate your feedback about our products.