

Simplifying
Complexity

NETVIO

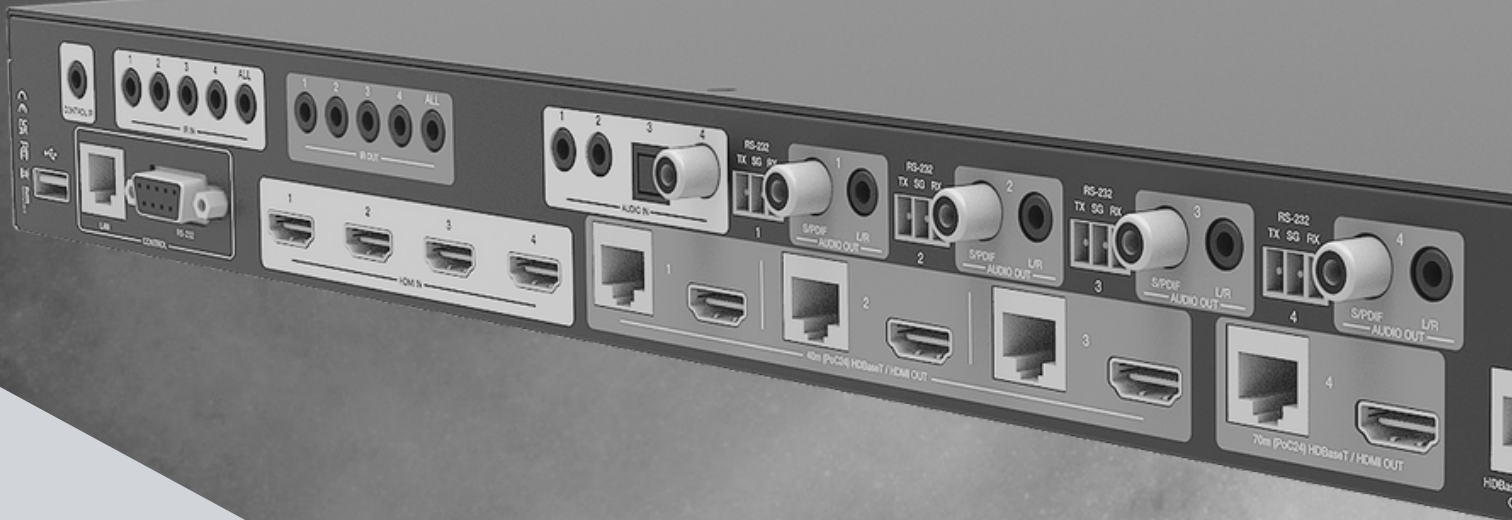

USER GUIDE

MX-HT2-0404-10 V2

AUDIO | VIDEO | DATA | SOFTWARE



4x4 Matrix

MX-HT2-0404-10

NETVIO

INDEX

Page 1

- Grab & Go information
- Process to success

Page 2

- Safety Information
- Warranty
- In-the-box
- Important installation guidance

Page 3

- System Wiring

Page 4

- Product features

Page 5

- Cable & connector guidelines
- Which HDBaseT receiver?

Page 6

- Which HDBaseT receiver? cont.

Page 7

- Front panel

Page 8

- Rear panel

Page 9

- Rear panel continued
- IR accessories, wiring & guidelines

Page 10

- Netvio 360 - Setting up your HT2 Matrix

Page 11

- Netvio 360 - Configure end-user control APP

Page 12

- Netvio GO - end user control APP

Page 13 & 14

- Specifications

Page 15

- Contact details

GRAB & GO



- IP Settings: DHCP (auto assigned without DHCP)
- Serial Settings: 115200 Baud, 8n1
- Default User Name/Password: admin/password
- Factory reset: Press & hold output 2 for 40 seconds (display will confirm)
- Network settings reset: Press & hold output 1 for 40 seconds (display will confirm).
- Netvio 360 download: www.netvio.co.uk
- Netvio GO APP download: www.netvio.co.uk
- Product instruction videos: www.netvio.co.uk/matrix/mx-ht2-0404-10

Product Support: support@netvio.co.uk | Instant Chat | UK (0870) 448 7001



Watch the latest instructional videos for the MX-HT2-0404-10 at www.netvio.co.uk/products/mx-ht2-0404-10



Process to success



Read safety information & installation guidelines. Find a safe home for your matrix device.



Read cabling recommendations & connector termination requirements. Test cabling before connecting Netvio devices.



Download the Netvio360 configuration software from www.netvio.co.uk/download



Connect Netvio device and PC/MAC to the same network.



Download the Netvio GO free AV control application for each end-user device using the following QR codes.



Safety Information



Attempts to remove product casings could result in electrical shock. Please do not attempt to repair the device. In the event of product service requirements, please contact Netvio Ltd or an authorised reseller for service procedures. Any unauthorised attempt to repair the product or attempts to replace components with non-approved parts will invalidate the product warranty. For full warranty conditions, please visit www.netvio.co.uk

Quick Start Guide

Thank you for purchasing this Netvio product. The quick-start-guide is designed to provide all required information to install your product successfully, ensuring correct installation standards, therefore guaranteeing performance in accordance with published features and specifications. Netvio therefore greatly appreciates your time in reviewing the provided information and following our recommended guidelines.

MX-HT2-0404-10

Premium 4x4 Matrix using Gen. 2 HDBaseT transmission technology delivering 4K/60 4:4:4 HDR capability over a dedicated single cable infrastructure or full 18Gbps pure HDMI outputs. The HT2-0404 includes a host of free-on-board features including onboard scaling, audio distribution & routing, ARC capture, both 40m & 70m output capabilities as well as compatibility with Netvio's 360 embedded configuration utility and Netvio GO end-user full spectrum AV control applications.

NETVIO 360



Before starting the installation, we recommend that you download the Netvio 360 utility software from www.netvio.co.uk. This provides easy configuration of the HT2 matrix. In addition, 360 provides the gateway to the Netvio GO AV control application for Apple and Android devices. You will require the product serial & product part number as a part of the software validation process.

Warranty

- 3-year standards parts & labour warranty.
- Additional 2-years subject to online registration within 90-days of installation.
- Safeguard 10-Year | 10% option available.
- Full warranty terms & conditions & online registration available at www.netvio.co.uk

In the box

- 1no. Netvio matrix device.
- 1set Regionalised IEC power lead.
- 1 pair of 19" mounting brackets
- 4no. IR emitters
- 4no. IR receivers
- 4no. IR to IR cables
- 4no. 3-Pin serial connectors
- 1no RS-232 connection cable
- 1no master remote

Important Installation Guidelines

- Prior to configuration, please ensure the matrix is properly seated on a flat, secure surface or housed in a suitable rack mount with ample space for airflow and heat dissipation. Avoid direct contact with sources of heat such as heating systems or audio amplifiers. Operating environment should not exceed stipulations of 0°C / +40°C | 20% - 90% RH
- A suitable wired or wireless network with a router supporting DHCP (Dynamic Host Configuration Protocol) is required where both Matrix and computer are connected to the same network.
- If a suitable router or DHCP server is not available, a direct network connection between computer and Matrix is supported, with both computer and Matrix set to auto assign IP addresses, where Netvio360 will discover the device and guide you through the set-up.

Control4

CRESTRON

RTI

ELAN

Drivers available at www.netvio.co.uk

System wiring suggestion

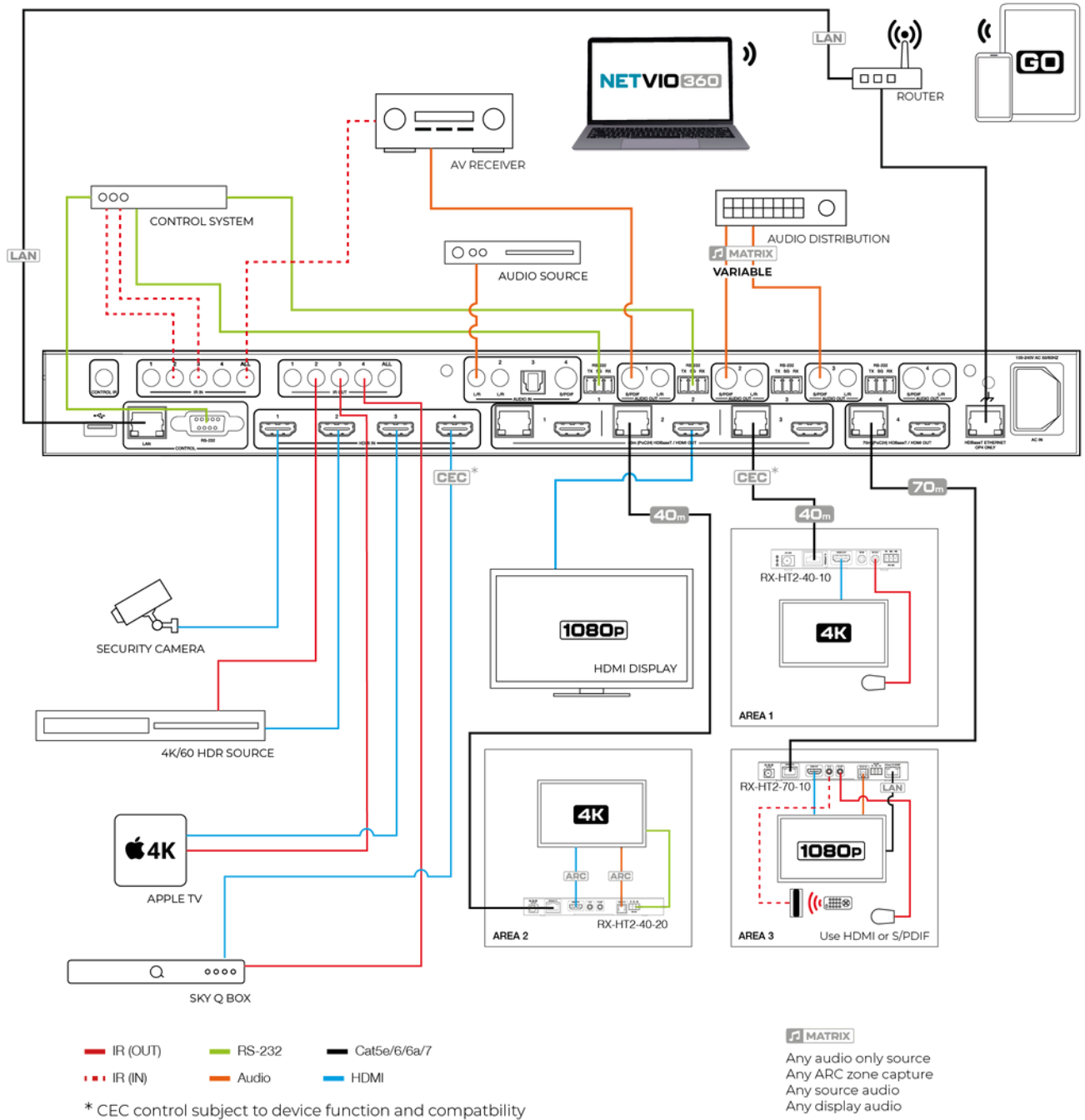

Cable & Connector Guidelines

- Advertised cable distances are for guidance only. Many factors can effect transmission distances including cable construction, quality, install standards, patch panels, faceplates and external factors such as electromagnetic interference (EMI).
- This product is designed to run over unshielded twisted pair Cat5e/6/7 cable. Some consideration is required when installing shielded (STP) category cable ensuring all drain wires and shielding are correctly grounded.
- All RJ45 terminations should follow EIA/TIA-568-B terminations and not simply wired Pin 1-1, Pin 2-2. The 568-B standard involves the splitting of the green pair to pins 3 & 6.
- Maintain twists within the Cat5e/Cat6/Cat7 cores up to the point of termination.
- Maintain gradual bends when installing category cable, ensuring a minimum radius of 25mm where possible. Avoid sharp bends or twists in the cable avoiding taught or stretched cable at all times.
- When dressing the cable use moderate to low pressure, avoiding pinching of the cable jacket.
- Do not splice, join or bridge the cable at anytime, as this will undoubtedly cause transmission issues.
- Use moderate to low pressure when pulling category cable avoiding pressures in excess of 11kgf (of force).
- Keep category cable away from sources of EMI (electrical cables, transformers, light fixtures) ensuring a minimum parallel distance of 300mm, crossing at right angles if absolutely necessary.
- Ensure cable is correctly tested, understanding that a basic continuity check may not be sufficient to identify issues or to certify cable performance.
- Always check local regulations relating to building and fire codes.

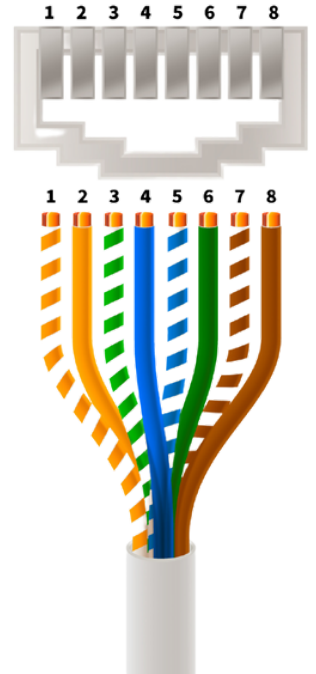

Which HDBaseT Receiver?

Any Netvio receiver will work on any matrix output regardless of supported features. To gain the best performance and to achieve the most cost effective install, please follow the features described below. Additionally, check the supported performance of each output, as they can vary. Matching the right extender and output capability will achieve the desired outcome.

RX-HT2-40-10

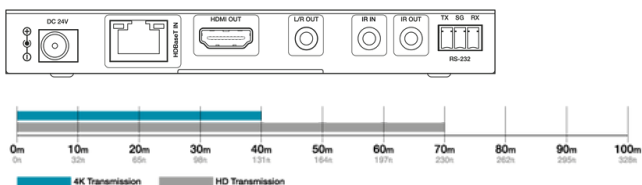

- Basic receiver supporting 4K/60 HDR | PoC | 2-Way IR | RS-232
- Can be used on all matrix outputs to achieve 40m 4K performance.
- 24v power-over-cable (PoC) feature means receiver is powered from the matrix. No PSU required.

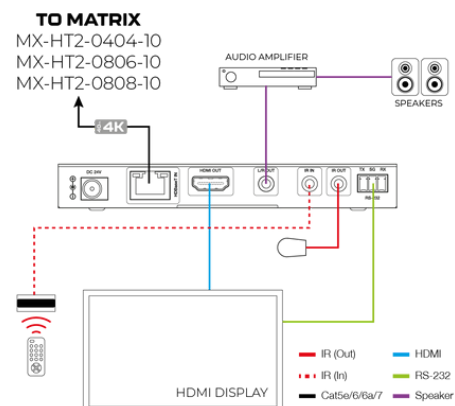

RX-HT2-40-20

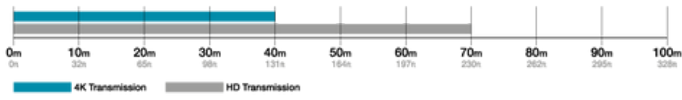

- Adding ARC capture & routing capability to all matrix outputs.
- Can be used on all matrix outputs to achieve 40m 4K performance.
- 24v power-over-cable (PoC) feature means receiver is powered from the matrix. No PSU required.

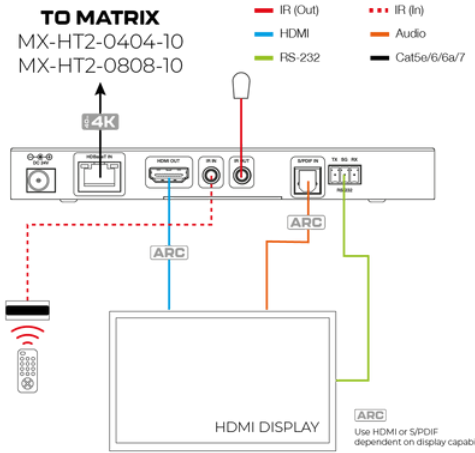

RX-HT2-70-10

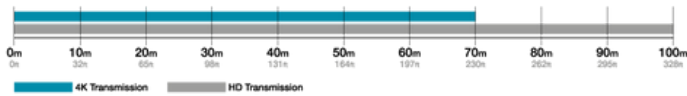

- Adding 70m 4K/HDR performance, including ARC capture & routing. To achieve full functionality, connect to Matrix output 4.
- Includes 100BaseT Ethernet pass-thru for smart TV or wireless access. To achieve full functionality, connect to Matrix output 4.
- The receiver can be connected to outputs 1-3, but features are output dependent, so 70m and LAN will not be supported.
- 24v power-over-cable (PoC) feature means receiver is powered from the matrix. No PSU required.

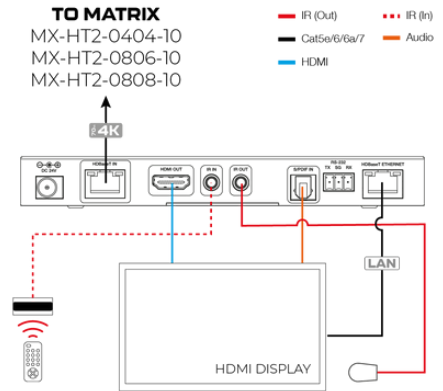

Product Features

- 4x4 HDBaseT multi-functional audio, video, data & control matrix.
- Compatible with all latest standards including HDMI2.0b & HDCP2.2.
- Supporting latest (18Gb) digital audio & video standards including HDR-10, HLG, Dolby Vision, DTS-X and Dolby Atmos.
- Accepts popular high bandwidth media sources providing seamless adjustments & transport over a dedicate HDBaseT AV network using Cat5e/6.
- Outputs (1-3) support 4K/60 HDR to 40m & 1080p to 70m.
- Enhanced output (4) performance provides 4K/60 HDR support to 70m & 1080p to 100m.
- Outputs (4) supports 100BaseT data transport over HDBaseT up to 100m.
- All outputs support 4K/1080p scaling. Pure HDMI outputs have independent scaling.
- ARC capture and routing from all connected display to both analog & digital zoned outputs.
- Accepts up to four 'audio only' source inputs with ability to distribute, embed and output from any analog or digital output.
- 16x8 independent audio matrix with DSP.
- All outputs supported by full 18Gb HDMI mirror outputs (with scaling) for local AVRs, more displays or connectivity to other Netvio devices.
- Both direct zone and routed RS-232.
- Cost effective SafeGuard enhanced product protection for up to 10-years for 10% additional cost.
- Netvio GO - Free full spectrum AV control APP for Apple and Android devices. Supports full API including independent audio and video switching, volume, media source and display control. Control methods include bi-directional IR, RS-232, CEC & IP, without the need for additional system hardware.
- Netvio 360 – Free cross platform discovery, configure, optimise & design software.
- 3no. compatible receivers to achieve desired budget and function.
 - RX-HT2-40-10: All the basics of 4K/60 HDR to 40m, 1080p to 70m. Apply to all outputs for lowest budget option.
 - RX-HT2-40-20: Adding ARC capture support to any output.
 - RX-HT2-70-10: 70m 4K/60 HDR to 70m, ARC capture & 100BaseT Ethernet. Perfect match for enhanced output (4).
 - Please check functionality of matrix outputs to ensure required features are available.

Front Panel

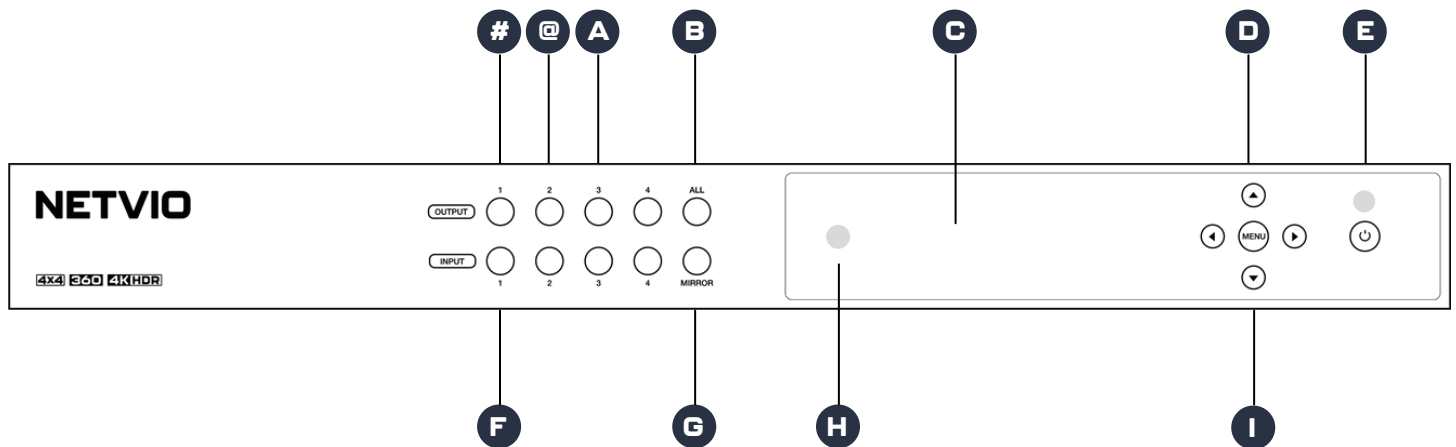

- #** Output - 1 **Dual purpose function.** In normal operation, it allows you to select output 1, followed by the input selection to initiate a manual video switch. However if this button is pressed and held for 40s it will **reset all network settings**, returning to factory default. The LCD display will provide confirmation of reset.

- @** Output - 2 **Dual purpose function.** In normal operation, it allows you to select output 2, followed by the input selection to initiate a manual video switch. However if this button is pressed and held for 40s it will **reset all settings**, returning to factory default. The LCD display will provide confirmation of reset.

- A** Output Selection Use any of the output numbers to select a display, followed by a video input button below, to initiate a manual video switch.

- B** All Displays Pressing the ALL button, followed by an input selection will send the video source to all connected displays.

- C** Status Display LED display showing status of input/output, current IP settings, RS-232 settings & EDID input status for each output. Use the MENU button to scroll through options, using arrows to navigate. Use MENU to return to home position.

- D** Menu Arrows Use the MENU button to scroll through options, using arrows to navigate. Use MENU to return to home position.

- E** Standby LED Red LED indicates that standby mode is active.

- F** Input Selection Use any of the input selection buttons after selecting the required output to initiate a manual video switch.

- G** Mirror One button press to initiate output 1 to input 1, output 2 to input 2 etc.

- H** IR receiving window Area to focus direct IR commands

- I** Power standby button Press & hold for 3 seconds to put matrix into standby mode. Short press to wake Matrix.

Rear Panel

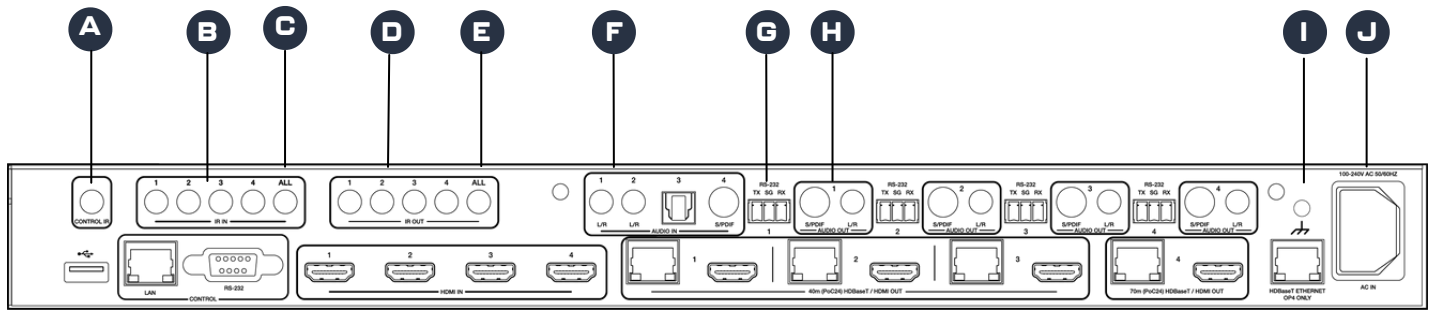

- A** Global IR Input Port Provides overall basic control limited to switching & routing video inputs and outputs. Can be used in conjunction with basic IR remote which is included.
-
- B** IR Input Ports Used to send IR signals to a specific display area. Useful applications include sending IR signals from a 3rd party control system to a display area. For this application it is important to use the provided 3.5mm to 3.5mm jack cable between matrix and control system IR output ports. Netvio does not support the use of 3rd third party IR accessories.
-
- C** Global IR Input Port Allows a single cable connection to send an IR signal to all displays simultaneously. For this application it is important to use the provided 3.5mm to 3.5mm jack cable between matrix and control system IR output ports. Netvio does not support the use of 3rd third party IR accessories.
-
- D** IR Output Ports Used to send IR signals received from the display location, then repeated to a media source via a supplied IR emitter cable. Netvio does not support the use of 3rd third party IR accessories.
-
- E** Global IR Output Port Allows a single cable connection to send an IR signal to all media sources simultaneously. For this application it is important to use the provided 3.5mm to 3.5mm jack cable between matrix and control system IR output ports. Netvio does not support the use of 3rd third party IR accessories.
-
- F** Audio Only Device Inputs Both analog and digital audio only inputs. Audio only inputs can be routed according to zone output or embedded onto HDMI content. Control of Audio routing can be achieved through the Netvio GO iOS, iPadOS and Android application or via the published API available online at www.netvio.co.uk
-
- G** Direct Zone RS-232 Point-to-point bi-directional communication from 3rd party control system to a single display location. Ensure TX and RX to TX wiring (including ground connections), Always use the provided green 3-pole connectors for matrix side. At the display area, RS-232 connections are made available on all Netvio HDBaseT receivers.
-
- H** Audio Outputs Zone dedicated analog and digital outputs. S/PDIF supporting multi-channel. 3.5mm jack socket supporting L/R stereo audio. Both outputs can operate simultaneously. Outputs can receive audio signals as a part of audio matrix function and controlled through API or Netvio GO applications for iOS, iPadOS and Android.
-
- I** Ground Connection Ground screw for 3mm tag.
-
- J** Power Connection Universal mains power connection. IEC power cable provided.

Rear Panel Continued

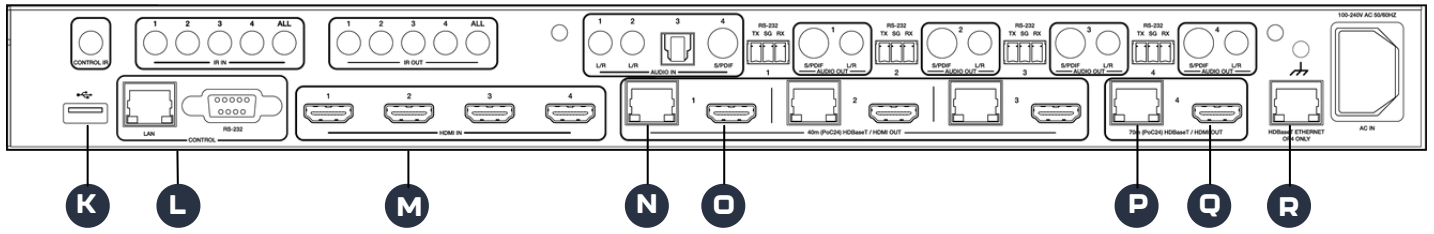

- K** USB Charging Ports USB charging function only. Provision for future product upgrade.

- L** Communication Ports RJ-45 network connection for IP control. DHCP (auto assigned without DHCP). Required connection for use with Netvio 360 configuration utility. RS-232 serial communication via 9W D connection. RS-232 interface cable provided.

- M** HDMI Media Inputs Capable of accepting latest 18Gb 4K/60 HDR sources. Connection should be made with good quality HDMI leads (not supplied)

- N** 40m HDBaseT Output Outputs 1-3 support 4K/60 HDR to 40m using good quality Cat5e/6 cabling. 70m is achievable when passing lower resolutions such as 1080p. These outputs also support ARC capture & routing, subject to using a RX-HT2-40-20 receiver. Each output can be configured by the Netvio 360 dealer utility, for example EDID and Scaling.

- O** HDMI Mirror Output These HDMI outputs mirror the matching HDBaseT (RJ45) output above, but are capable of independent scaling configurations via the Netvio 360 dealer utility. Outputs support 4K/60 HDR.

- P** 70m HDBaseT Output Output 4 supports 4K/60 HDR to 70m using good quality Cat5e/6 cabling. 100m is achievable when passing lower resolutions such as 1080p. This output also supports 100BaseT Ethernet pass-thru, ARC capture & routing by using a RX-HT2-70-10 receiver.

- Q** HDMI Mirror Output These HDMI outputs mirror the matching HDBaseT (RJ45) output above, but are capable of independent scaling configurations via the Netvio 360 dealer interface.

- R** HDBaseT Ethernet LAN connection providing network connectivity at connected displays areas by using RX-HT2-70-10 receiver connected to output 4.

IR Accessories

- Netvio strongly recommends the use of provided IR accessories. Netvio does not support 3rd party IR components because certain voltage requirements can not be guaranteed. Positioning of IR devices is critical to satisfactory performance. It is often a 2-person task. 1-person firing remote commands from the display area. 2-person finding the best position on media source. Moving the IR emitter around maybe needed to find the sweep spot.
- IR devices that use the same IR commands will likely receive the commands from other outputs emitters, even if placed on a different shelf. IR bounces off surfaces, so even if there is no direct line of site, multiple units may respond to each command. Netvio recommends the use of IR emitter shields to prevent this from happening.
- Although we do not recommend the process, Netvio understands that cable modifications maybe needed to connect to some 3rd party devices. Please see the following schematics.
- A basic IR remote is provided to testing purposes or to provide IR frequencies for a learning remote. Basic operation includes the selecting of the required output, followed by the input selection.

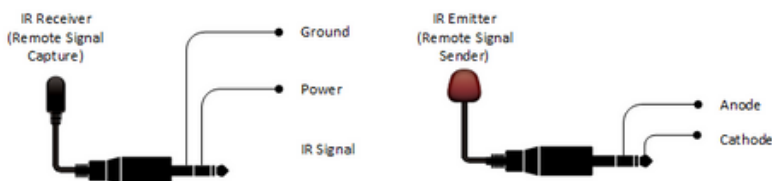

360

NETVIO 360 | NEXT LEVEL DEALER INTERFACE

Netvio 360 is a brand new dealer interface for multiple technologies which provides auto discovery, configuration and product optimization. Connect PC or Mac and Netvio device to the same network, start the 360 application, hit auto-discovery, and then sit back and see devices populate the screen.

The 360 dealer utility provides all configurations, in an easy to follow user-interface. Advanced settings includes:

- Video functions including scaling settings per output.
- EDID configuration.
- Powerful Audio menu including ARC & independent audio routing.
- Advanced security settings.

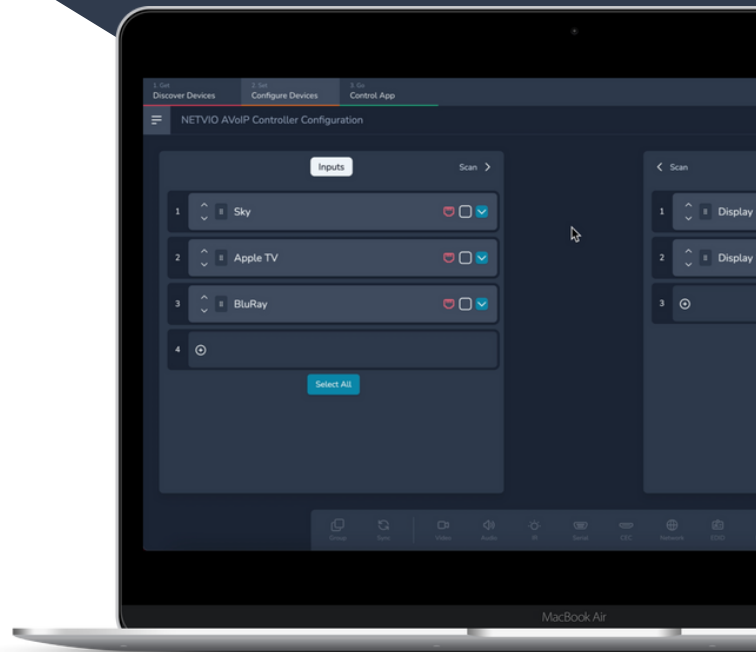

Getting started.

- Ensure you have downloaded the latest version of Netvio 360 from www.netvio.co.uk/download - software is available for both Mac and PC.
- You may get a series of warnings flagged by anti-virus software. As long as you have downloaded the 360 software direct from the Netvio website, there is no security risk to your PC or MAC.
- A suitable wired and wireless network with a router supporting DHCP (Dynamic Host Configuration Protocol) is required where both matrix and computer are connected to the same network.
- A direct cabled connection between computer and matrix is supported, with both computer and matrix set to auto assign IP addresses, where Netvio 360 will auto discover the matrix and guide you through the set-up.
- Once you have downloaded the Netvio 360 utility and established the matrix and computer on the same network, launch the 360 utility and **Scan for devices**. Once discovered, **hit configure**.
- Netvio 360 is an intuitive software platform, with many settings easily on hand. In most cases product default settings will be sufficient, but further settings are available and highlighted at the bottom of the screen.

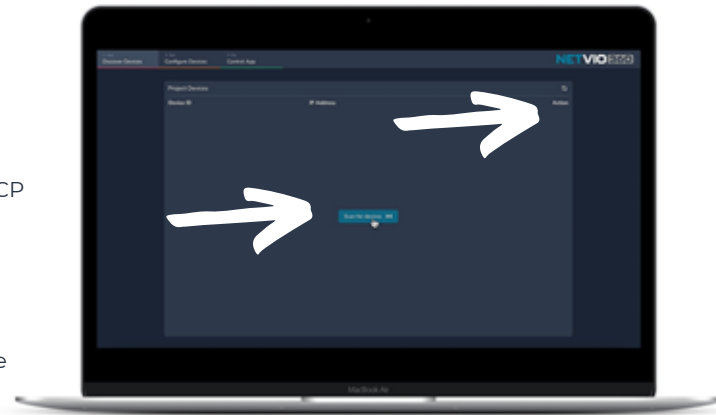

More in-depth instructional videos on how to use Netvio 360 including more advanced set-ups can be found at www.netvio.co.uk/products/mx-ht2-0404-10

Control4

CRESTRON

RTI

ELAN

Drivers available at www.netvio.co.uk

360

From a doodle to onscreen AV system design

How many times does a system design start out as a sketch or doodle on a notepad? Netvio 360's visual design tool is an extension of precisely that. Add, drag and drop displays, media sources and audio products.

Finger-draw AV connections, control paths for each device selecting from IR, RS-232, IP and CEC*, then group displays into single or expanded zones, add custom images to area/zone buttons.

What seems to be an innocent line between your on-screen system components is actually automating complex micro drivers which form all coding elements, ready for end-user control via smart phones and tablets. You are now entering into the world of Netvio GO.

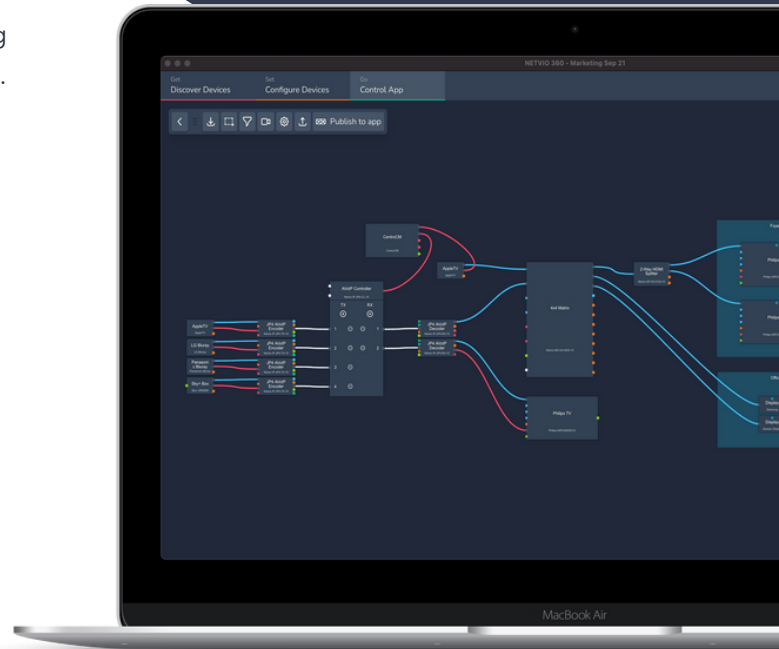

DOWNLOAD NETVIO360 to your PC or MAC
at www.netvio.co.uk/download

- Once you have finished configuring the matrix you can exit the Netvio 360 platform and download relevant drivers for your 3rd party control system. Available drivers are available at www.netvio.co.uk
- Alternatively, you can you proceed and create a Netvio GO project by pressing 'Create APP Project'.
- You will enter a drag 'n' drop configuration environment which will be pre-populated with your Netvio device in the center of the screen together with some other devices to get you started.



More in-depth instructional videos on how to use Netvio 360 including more advanced set-ups can be found at www.netvio.co.uk/products/mx-ht2-0404-10



Full spectrum AV control experience



- Netvio GO is your end-user AV control application, intrinsically linked with 360 software. Working with Netvio integrated product I/Os, it is possible to remove dedicated control processors from many applications.
- Compatible with iOS, iPadOS and Android, Netvio GO can control any AV device via IR, RS-232, CEC and IP to manage signal distribution, media sources, displays and audio products. Simply add each smart user device by scanning a 360 software generated QR code or download the uploaded project directly from the matrix.
- Netvio GO can be used as a simple AV control platform, or complement a traditional control system by adding secondary zones at effectively zero cost. Simply with your phones camera to start the process.



More in-depth instructional videos on how to use Netvio GO be found at www.netvio.co.uk/products/mx-ht2-0404-10

Control4

CRESTRON

RTI

ELAN

Drivers available at www.netvio.co.uk

Specifications

VIDEO

- Compatible Receiver Devices:
 - RX-HT2-40-10: 40m 4K/60 HDR | 70m 1080p | 2-way IR, RS-232 & PoC.
 - RX-HT2-40-20: 40m 4K/60 HDR | 70m 1080p | ARC, 2-way IR, RS-232 & PoC.
 - RX-HT2-70-10: 70m 4K/60 HDR | 100m 1080p | Ethernet, ARC, 2-way IR, RS-232 & PoC.
- Encoding Data Rate
 - HDMI: Max 17.82Gbs
 - HDBaseT: Max 10.2Gbs subject to variable stream compression and up-conversion.
- Max Video Transmission
 - 3840x2160 60fps 4:4:4 8b
- HDBaseT
 - Outputs 1-3 | HDBaseT (10.2Gb) @ 40m 4K/60 HDR | 70m/1080p.
 - Output 4 | HDBaseT (10.2Gb) @ 70m 4K/60 HDR | 100m/1080p.
- HDMI (Inputs/Outputs)
 - Supporting HDMI 2.0b resolutions including 3840x2160 60fps HDR.
- Max Pixel Clock
 - 600MHz / 600Mcsc
- HDR Compatibility
 - HDR10, HDR10+, Hybrid Log-Gamma, Dolby Vision
- Scaler Function
 - 4K to 1920x1080 progressive
 - Modes include, pass-through (no scaling), Fixed 4K → 2K, Automatic
- HDCP
 - Inclusive up to 2.2

AUDIO

- Audio Formats:
 - LPCM 2ch, LPCM 5.1, LPCM 7.1, Dolby Digital, Dolby Digital Plus, Dolby TrueHD, DTS, DTS Master
- Audio Outputs:
 - 4no. 2ch variable line level stereo analog audio Jack socket
 - 4no. S/PDIF audio via female RCA socket, S/PDIF digital audio supporting uncompressed PCM and non-linear PCM-encoded bitstreams.
- Audio Return Channel:
 - ARC capture from compatible display, matrix & receiver (RX-HT2-40-20 | RX-HT2-70-10)
- Audio Only Inputs:
 - 2no. 2ch Stereo analog line audio inputs via jack socket
 - 1no. S/PDIF (supporting LPCM and proprietary bitstreams) audio via female RCA socket,
 - 1no. S/PDIF (supporting LPCM and proprietary bitstreams) audio via female optical TOSLink socket

- Audio Matrix
 - Inputs:
 - HDMI Source de-embed 1-8
 - HDMI ARC Zone 1-8
 - HDBaseT ARC Zone 1-8
 - Audio In 1, 2, 3, 4
- Outputs:
 - No.4 | Mirrored HDMI outputs
 - No. 4 | HDBaseT outputs
 - No. 4 | Stereo +S/PDIF

COMMUNICATION & CONTROL

- HDMI:
 - CEC, DDC
- HDBaseT:
 - Supports CEC, DDC, Ethernet, RS-232 TXD, RXD and Infrared
- RS-232:
 - Supports direct & routed RS-232 control, via a DB9 socket on the rear panel.
 - Zone RS-232 Serial interface (3-pin) via Phoenix-style, 3.5mm pitch male receptacle.
- LAN:
 - 1x IEEE 802.3u 100Base-TX Ethernet interface via "RJ45" socket.
 - Local discovery and API console via Netvio 360 & Netvio Go APP,
 - 3rd-party integration via public API
- Drivers & Control
 - Drivers available for control systems including C4, Crestron, RTi & Elan.
 - Discovery, configure, optimise, design via Netvio 360 utility.
 - Full spectrum AV control via FREE Netvio application for Apple & Android devices.
- 360 Utility:
 - 64-bit Windows 7 or later minimum 4GB RAM. MacOS 10.11 El Capitan or later, minimum 4GB RAM.
- GO End User Application:
 - iOS: iOS12 or later, 64-bit device. Android: v5.0 (lollipop) or later, 1GB RAM min.
- EDID: Automatic, Onboard pre-sets, Copy sync (RX)

ENVIRONMENTAL

- Storage: 20°C / +60°C | 20% - 90% RH
- Operating: 0°C / +40°C | 20% - 90% RH
- Power Supply: Internal PSU. supporting worldwide AC voltages (e.g. 120V/60 USA, 230V/50 UK)
- Weights & Dimensions: Rack Units: 1RU, Height: 44mm, Width: 440mm, Depth: 373mm
- Weight: 3.0kg

Contact Info

www.netvio.co.uk

Support:

E: support@netvio.co.uk

UK: +44 (0) 870-448-7001

US: +1 833-720-0637

Sales:

E: sales@netvio.co.uk

UK: +44 (0) 870-448-7001 | +44 (0) 7444 807 836

Netvio Ltd

InfoLab21

Lancaster University

Bailrigg Road

Lancaster, UK, LA1 4WA

